

Welcome to the Build Team

East Warren Tool Library

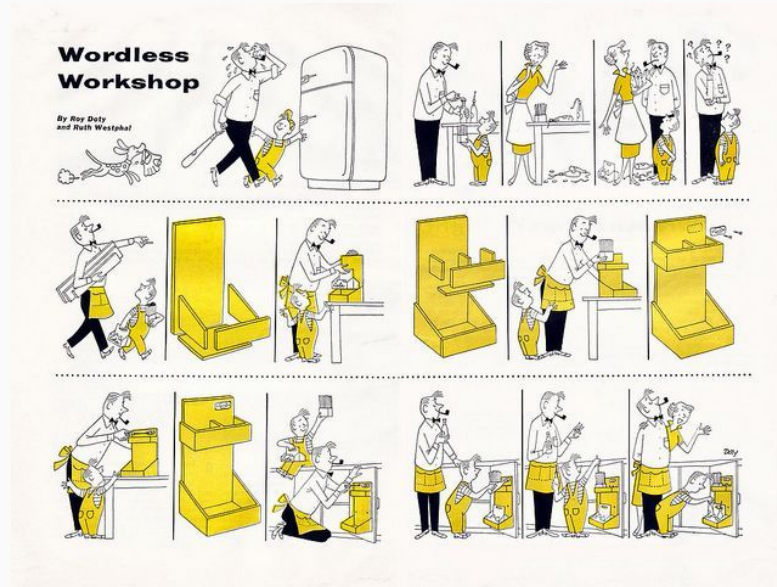

Giving homage to Wordless Workshop :)



What we're building

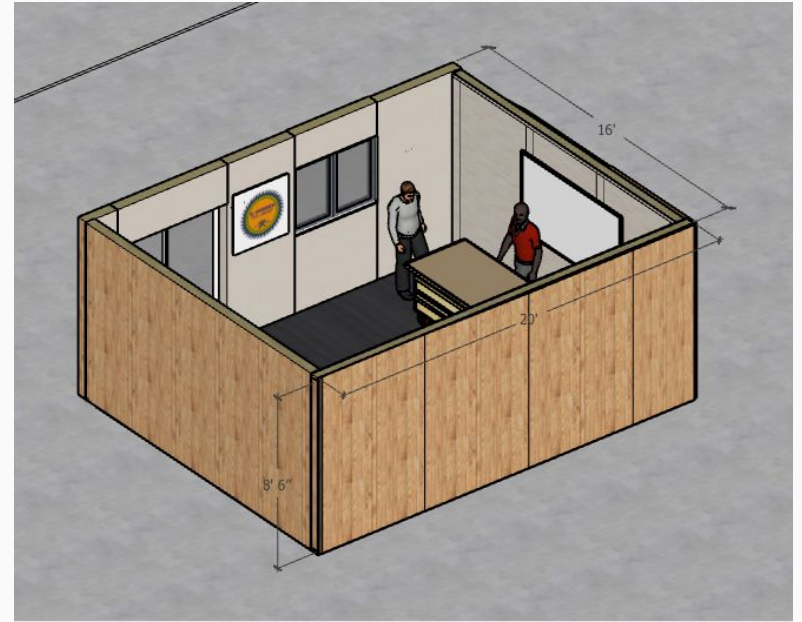

The floor

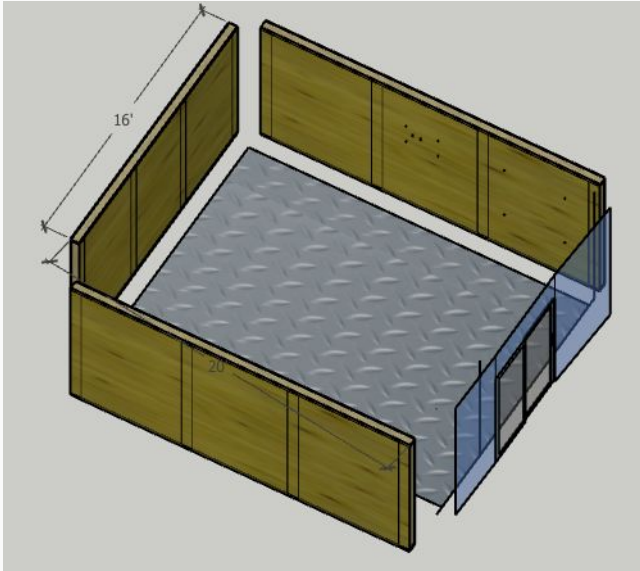

The foot

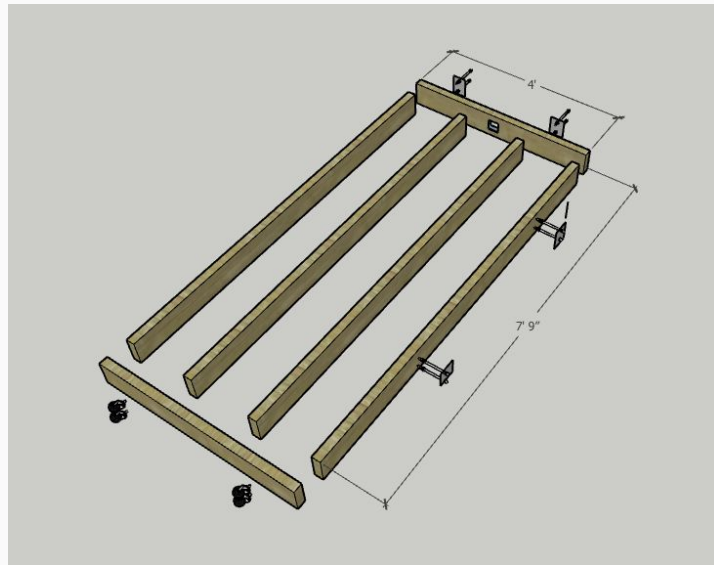
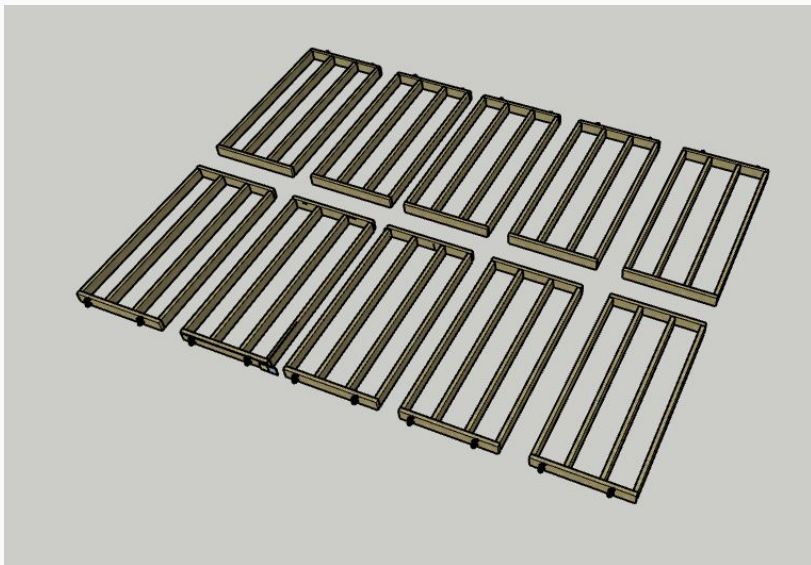

The walls

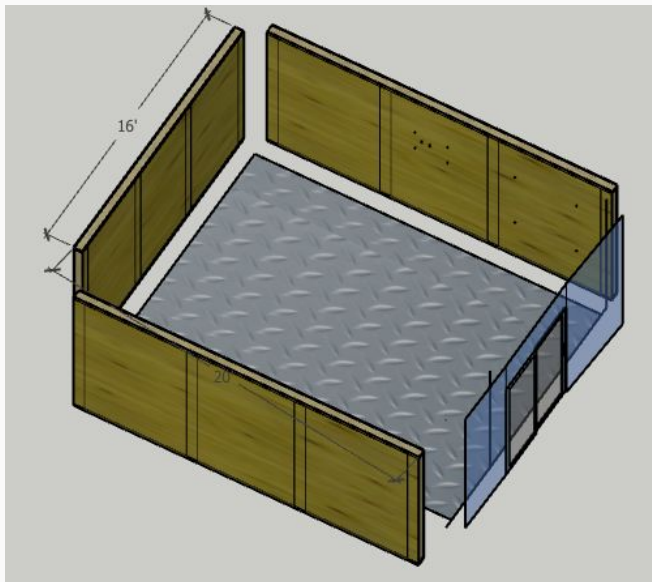

The walls

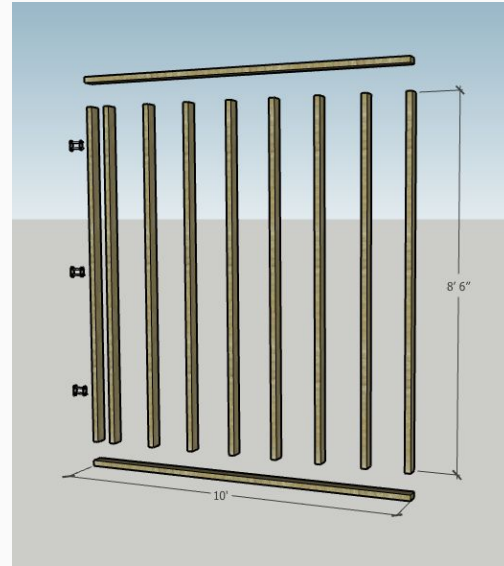
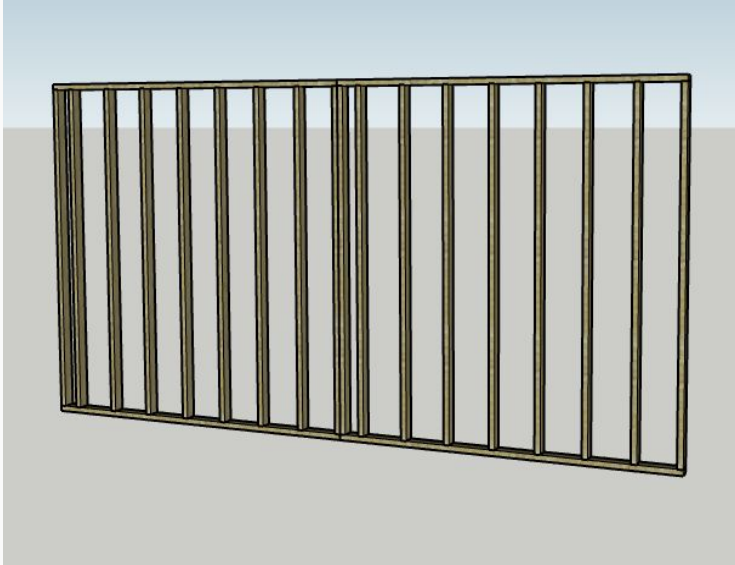

The ceiling

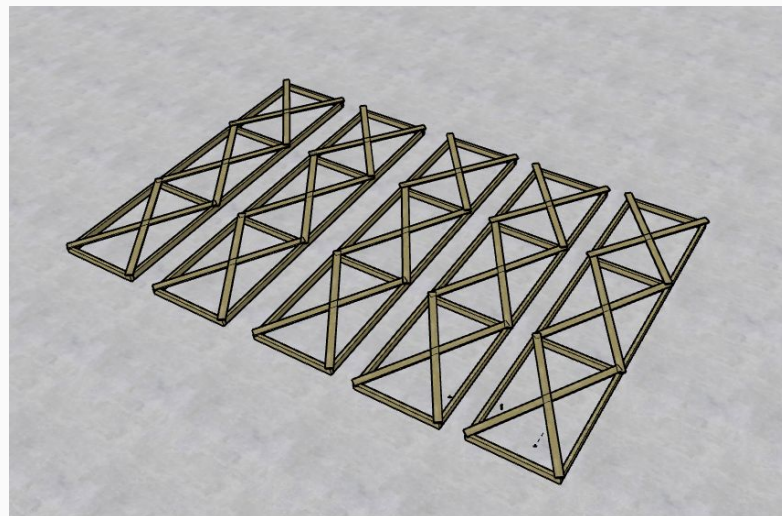
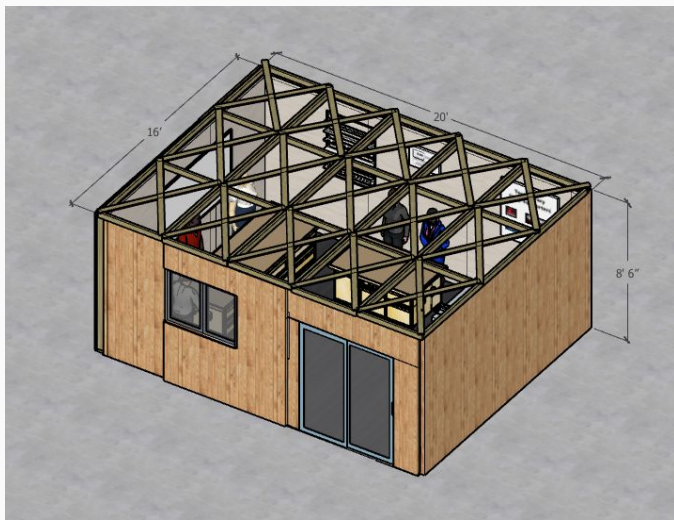

The ceiling

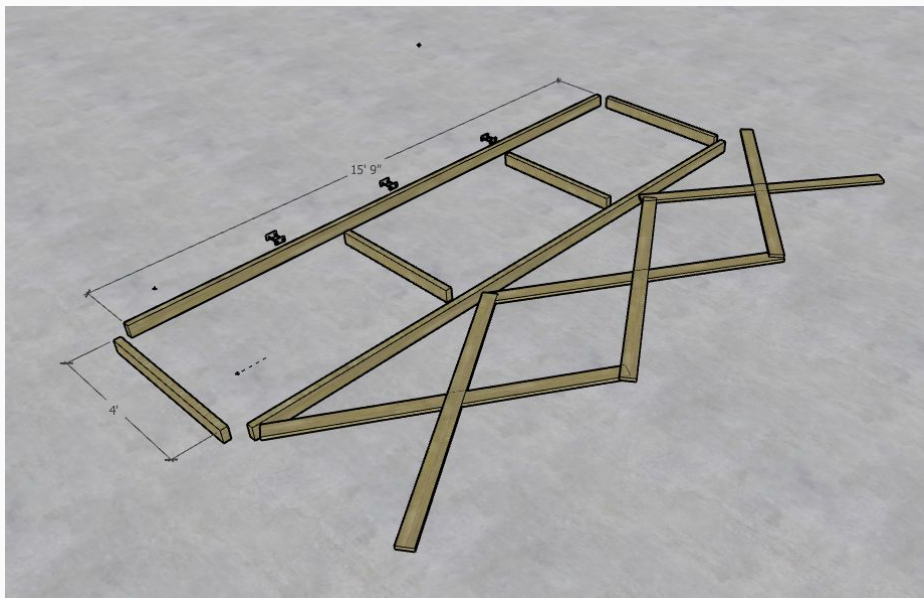

All the parts

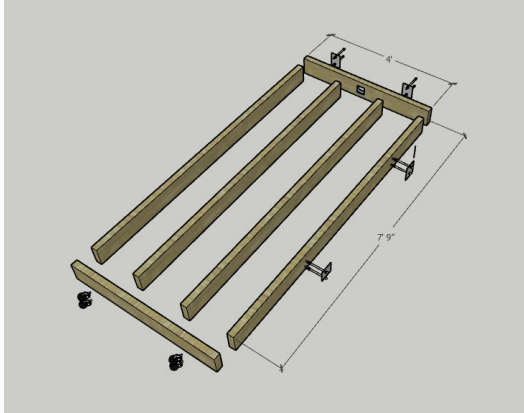

10 floors

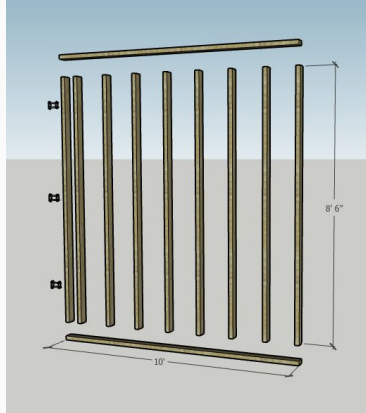

10 walls

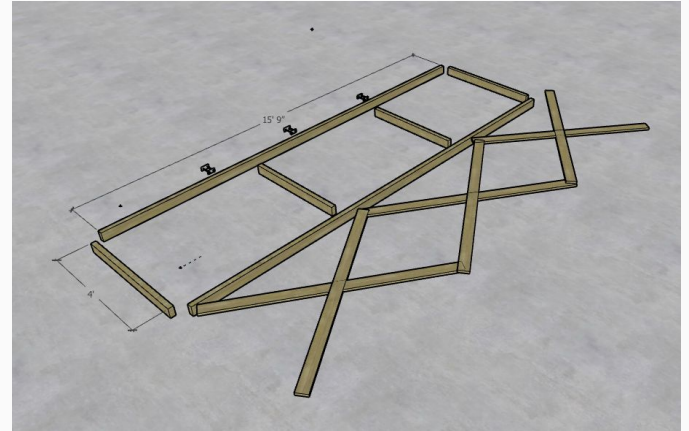

5 ceilings

Our timeline

Some terms

Build Meetings: two hour meetings for construction

Build Team: the total number of members constructing the shop

Construct Team: two members working together

Our timeline

- This proposed timeline incorporates some assumptions about the build time for components.
- The time it takes to build each component in the shop can be used as a goal.
- We can evaluate our performance toward making the goals and set new goals.

Our timeline

Weeks	1st meeting of the week	2nd meeting of the week
1	Discuss the project	CT1 = 1.25 floor sections CT2 = 1.25 floors
2	CT1 = 1.25 floors CT2 = 1.25 floors Total floors completed = 5	CT1 = 1.25 floors CT2 = 1.25 floors
3	CT1 = 1.25 floors CT2 = 1.25 floors <i>Floors finished</i>	CT1 = 1.25 wall sections CT2 = 1.25 walls
4	CT1 = 1.25 walls CT2 = 1.25 walls Total walls = 5	CT1 = 1.25 walls CT2 = 1.25 walls

Our timeline

5	CT1 = 1.25 walls CT2 = 1.25 walls	Total walls = 10	CT1 = 1.5 walls CT2 = 1.5 walls
6	CT1 = 1.5 walls CT2 = 1.5 walls	<i>Walls finished</i>	CT1 = 0.6 ceiling sections CT2 = 0.6 ceilings
7	CT1 = 0.6 ceilings CT2 = 0.6 ceilings	Total ceilings = 2.5	CT1 = 0.6 ceilings CT2 = 0.6 ceilings
8	CT1 = 0.6 ceilings CT2 = 0.6 ceilings	<i>Ceiling finished</i>	Shop assembly
9	Shop assembly	<i>Assembly finished</i>	

Learning Objectives and Project Expectations

Learning Objectives

- Proficiency with tools used in the shop construction
- Proficiency in measurement and geometry skills
- Efficient communication with Build Team members about the project

Build Team Expectations

- Attendance and participating in all agreed on Build Meetings